

COMMERCIAL
STAINLESS STEEL

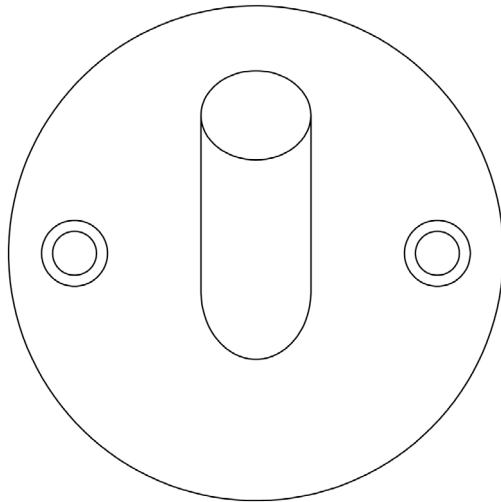

CODE

JSS902A

DESCRIPTION

Single Robe Hook

STANDARDS



PRODUCT SPECIFICATION

- *We strongly recommend requesting a sample before committing to any cutting or drilling*

TECHNICAL DRAWING

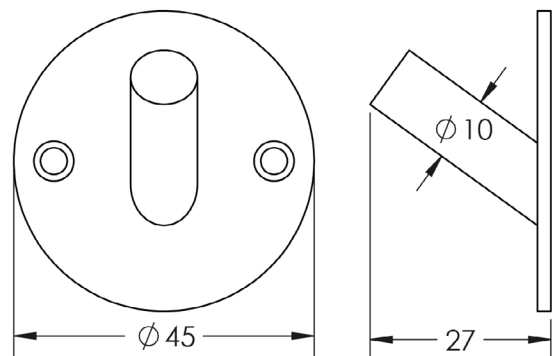

FINISHES

- Satin Stainless Steel