

COMMERCIAL
STAINLESS STEEL

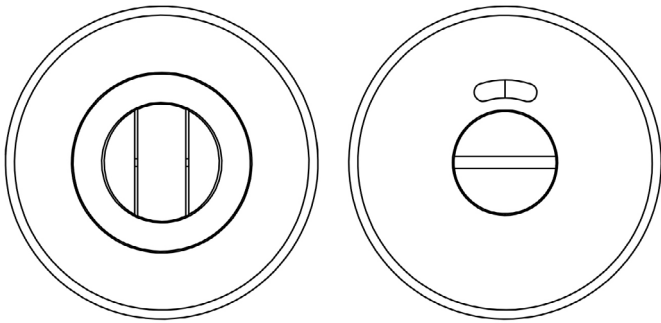

CODE

JSS55

DESCRIPTION

Turn & Release - Round, With Indicator

STANDARDS



PRODUCT SPECIFICATION

- Indicator rose
- Grade 5 corrosion

TECHNICAL DRAWING

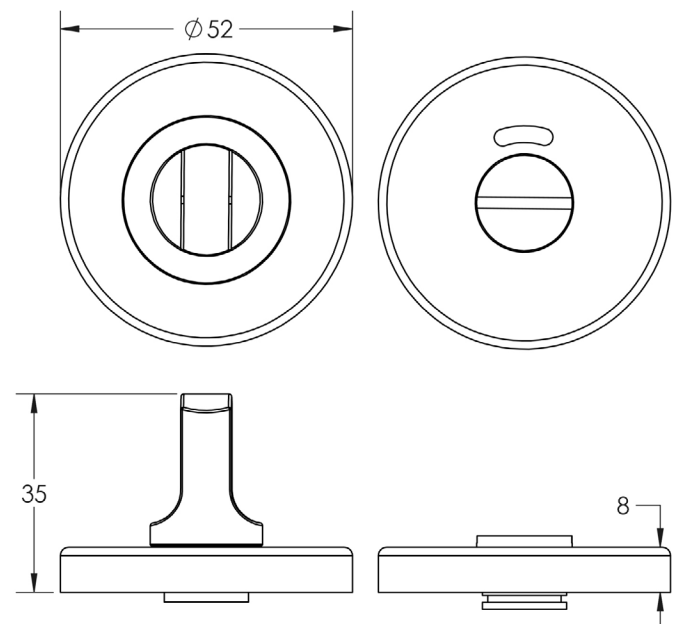

FINISHES

- Satin Stainless Steel