

COMMERCIAL
STAINLESS STEEL

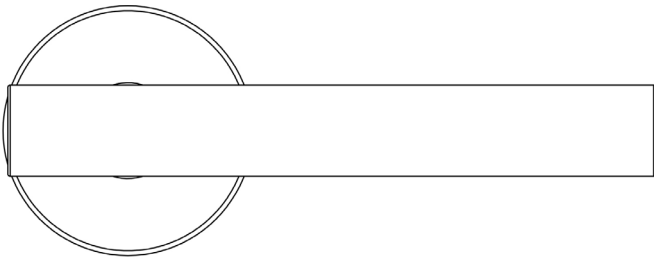

CODE

JSS412

DESCRIPTION

Mitred Lever On Rose

STANDARDS



PRODUCT SPECIFICATION

- Sprung
- Suitable door thickness - 35-54mm
- Grade 3 corrosion

TECHNICAL DRAWING

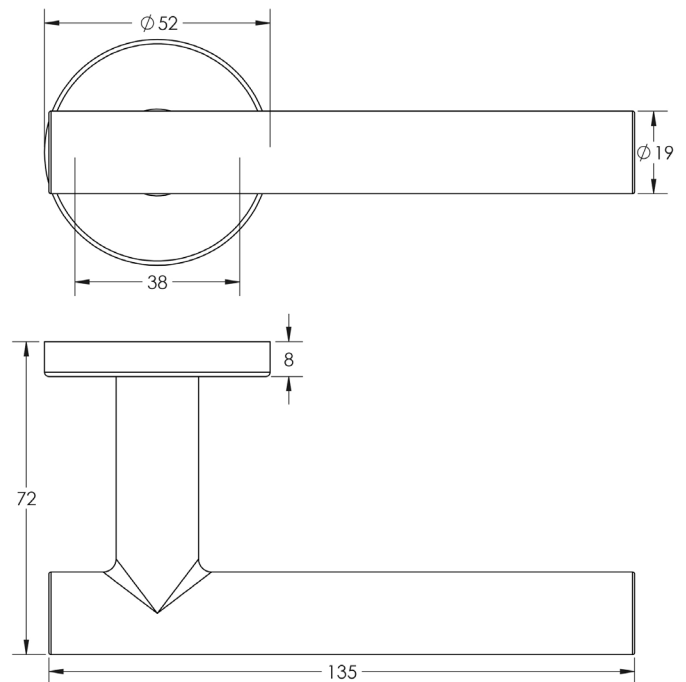

FINISHES

- Satin Stainless Steel