

### CODE

JL6666S-150

### DESCRIPTION

Double Sprung Tubular Latch

### STANDARDS

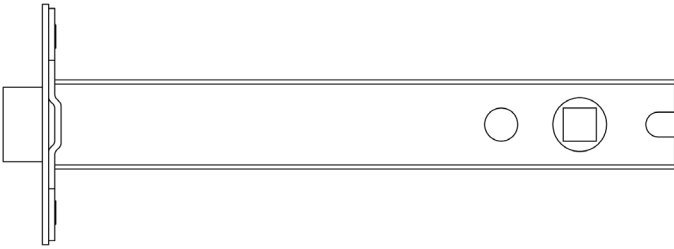

### PRODUCT SPECIFICATION

- 1mm interden rap
- 2 way latch
- Comes with SSS and PB forends and strikes
- Comes with black dust box

### TECHNICAL DRAWING

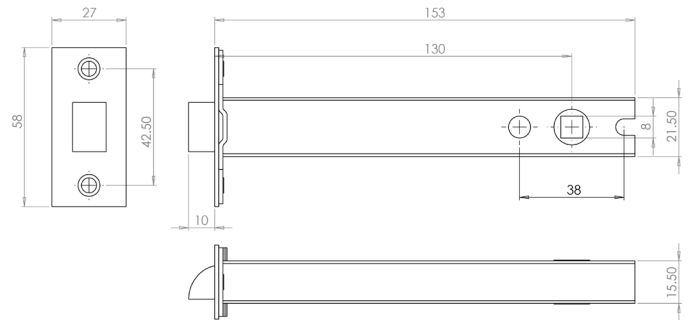

### FINISHES

- Polished Brass / Satin Stainless Steel