

CODE

JL-HDT102

DESCRIPTION

Heavy Duty Tubular Latch - Square

STANDARDS









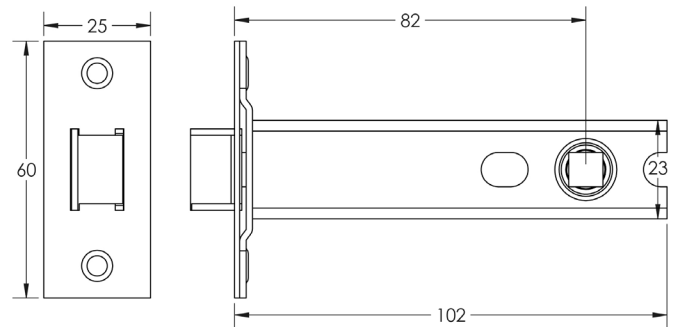

PRODUCT SPECIFICATION

- Sprung
- Suitable door thickness: 35-54mm
- Grade 3 corrosion
- Available in radius
- *We strongly recommend requesting a sample before committing to any cutting or drilling*

TECHNICAL DRAWING



FINISHES

	Antique Brass	JL-HDT102AB
	Black	JL-HDT102BL
	Dark Bronze	JL-HDT102DB
	Gun Metal	JL-HDT102GM
	Polished Stainless Steel	JL-HDT102PSS
	PVD Brass	JL-HDT102PVD
	Satin Brass	JL-HDT102SB
	Satin Stainless Steel	JL-HDT102SS