

CODE

JL-HDB102

DESCRIPTION

Heavy Duty Deadbolt

STANDARDS

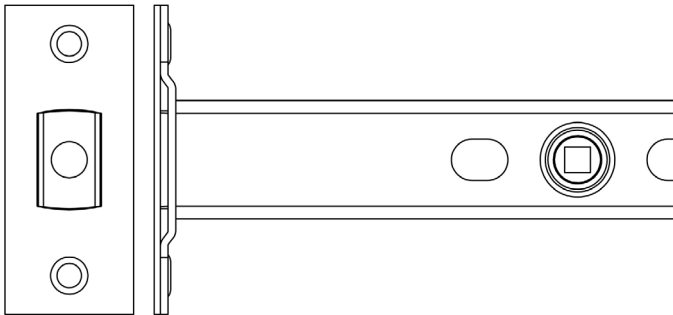







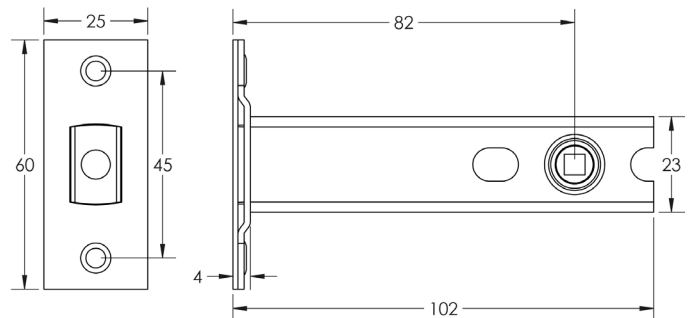

PRODUCT SPECIFICATION

- Sprung
- Suitable door thickness: 35-54mm
- Grade 4 corrosion
- Available in radius
- *We strongly recommend requesting a sample before committing to any cutting or drilling*

TECHNICAL DRAWING



FINISHES

	Antique Brass	JL-HDB102AB
	Black	JL-HDB102BL
	Dark Bronze	JL-HDB102DB
	Gun Metal	JL-HDB102GM
	Polished Stainless Steel	JL-HDB102PSS
	PVD Brass	JL-HDB102PVD
	Satin Brass	JL-HDB102SB
	Satin Stainless Steel	JL-HDB102SS