

CODE

HB3005-5PB / HG3005-5GY

DESCRIPTION

Double Action Spring Hinge

STANDARDS

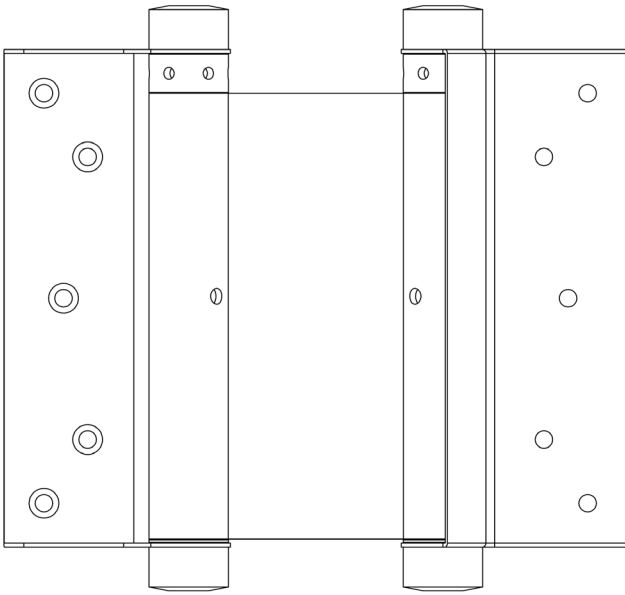

PRODUCT SPECIFICATION

- Suitable for 27kg doors when using 2 hinges
- Max door thickness 30-35mm
- Max door width 700mm
- *We strongly recommend requesting a sample before committing to any cutting or drilling*

FINISHES

- Electro Brassed (HB3005-5PB)
- Silver (HG3005-5GY)

TECHNICAL DRAWING

