

CODE

CR-802BK7

DESCRIPTION

SQUARE TURN & RELEASE - INDICATOR

STANDARDS

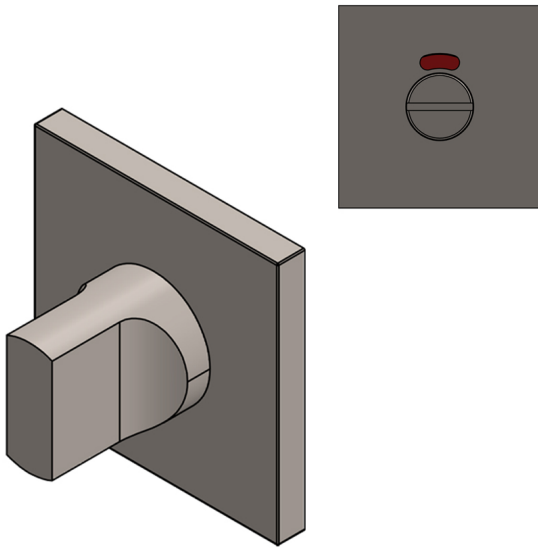



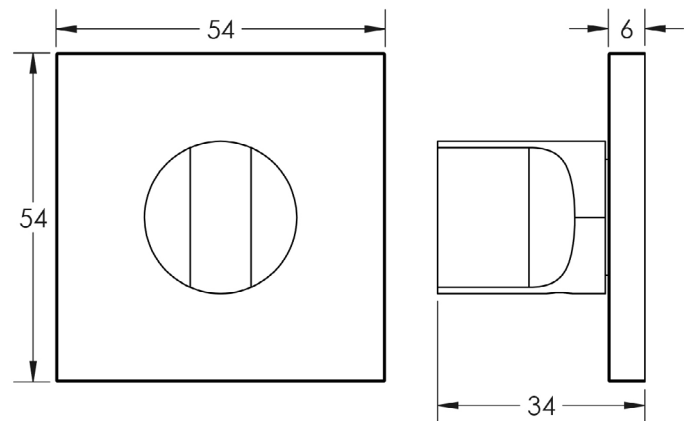

PRODUCT SPECIFICATION

- Grade 316 stainless steel
- PVD finishes (excluding SSS)
- Internal or external use
- Residential or commercial use
- 44mm max door thickness
- *Longer spindles available upon request*
- 25 years mechanical guarantee
- Grade 4 corrosion
- *We strongly recommend requesting a sample before committing to any cutting or drilling*

TECHNICAL DRAWING



FINISHES

	Antique Brass	AB
	Dark Bronze	DB
	Matt Black	MB
	Satin Brass	SB
	Satin Stainless Steel	SSS