

CODE

CR-801BK7

DESCRIPTION

SQUARE TURN & RELEASE - INDICATOR

STANDARDS

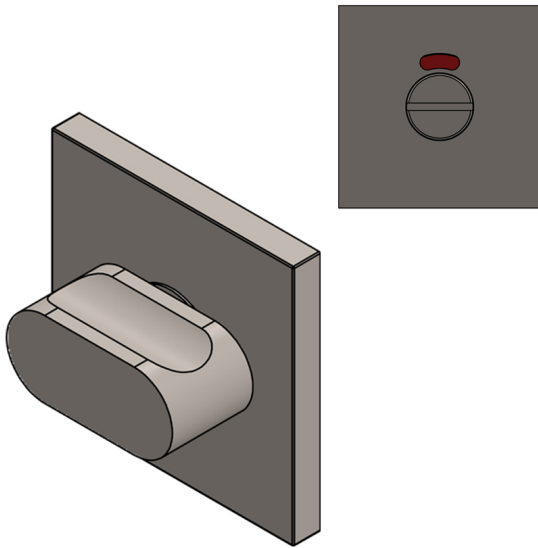

PRODUCT SPECIFICATION

- Grade 316 stainless steel
 - PVD finishes (excluding SSS)
 - Internal or external use
 - Residential or commercial use
 - 44mm max door thickness
 - *Longer spindles available upon request*
 - 25 years mechanical guarantee
 - Grade 4 corrosion
- *We strongly recommend requesting a sample before committing to any cutting or drilling*

TECHNICAL DRAWING

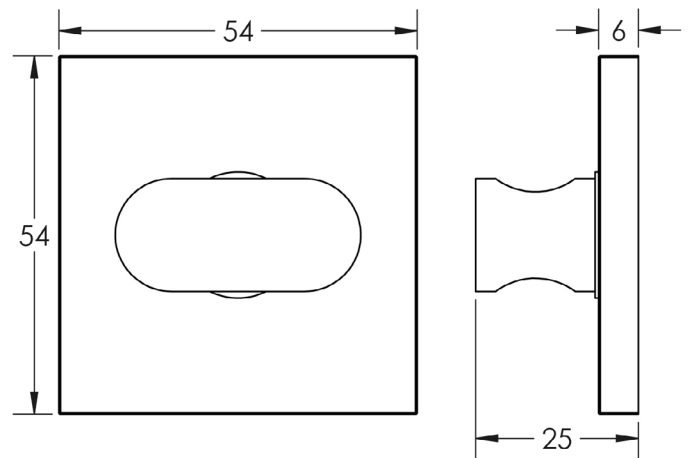

FINISHES

	Antique Brass	AB
	Dark Bronze	DB
	Matt Black	MB
	Satin Brass	SB
	Satin Stainless Steel	SSS