

### CODE

**BUR15KIT320**

### DESCRIPTION

**Lever On Plate**

### STANDARDS



### PRODUCT SPECIFICATION

- 38mm centres
- Sprung
- Latch plate
- Grade 4 corrosion
- Matt lacquered solid brass
- Back to back fixing recommended
- Suitable for doors 35-55mm

### TECHNICAL DRAWING

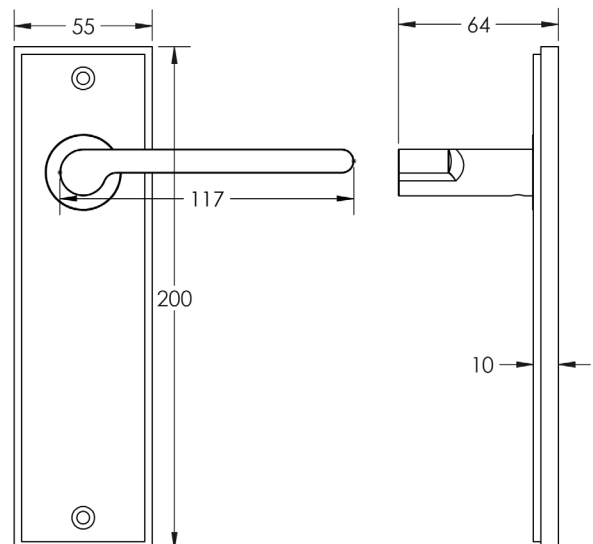

### FINISHES

- Satin Nickel

