

CODE

BUR-81SN-50SN

DESCRIPTION

Turn & Release

STANDARDS

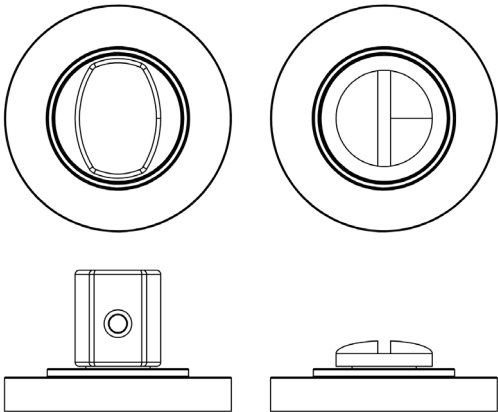

PRODUCT SPECIFICATION

- 38mm centres
- Plain rose
- Matt lacquered solid brass

TECHNICAL DRAWING

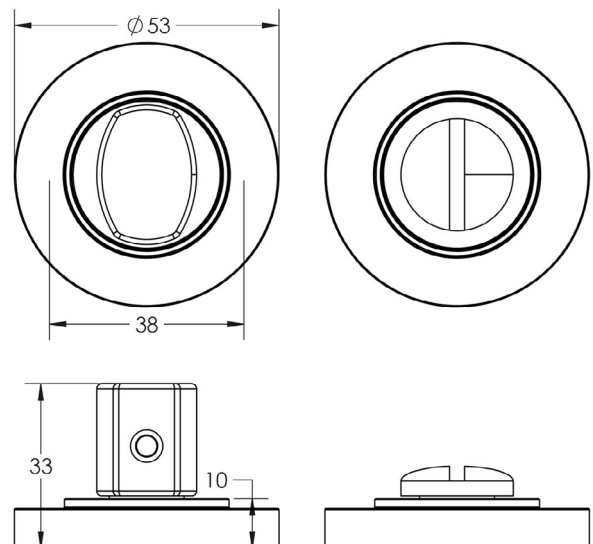

FINISHES

- Satin Nickel

