

CODE

BUR-81SB-53SB

DESCRIPTION

Turn & Release

STANDARDS

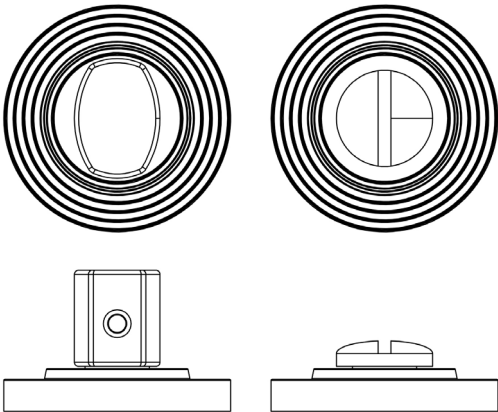

PRODUCT SPECIFICATION

- 38mm centres
- Stepped rose
- Matt lacquered solid brass

TECHNICAL DRAWING

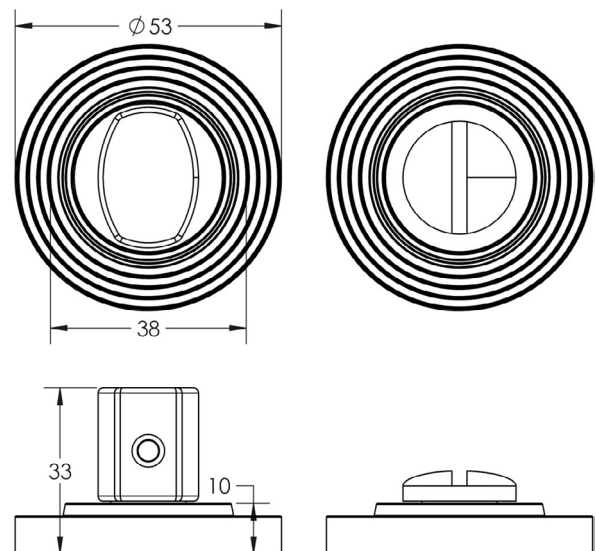

FINISHES

- Satin Brass

