

CODE

BUR-81SB-152SB

DESCRIPTION

Turn & Release

STANDARDS

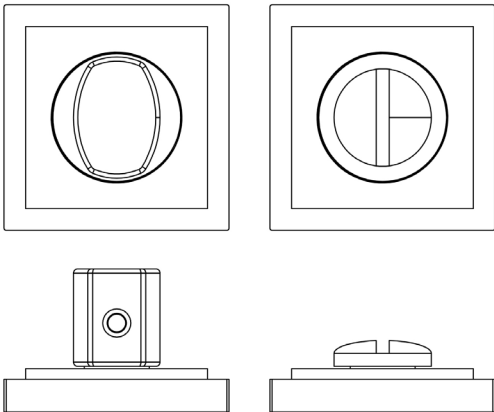

PRODUCT SPECIFICATION

- 38mm centres
- Square stepped rose
- Matt lacquered solid brass

TECHNICAL DRAWING

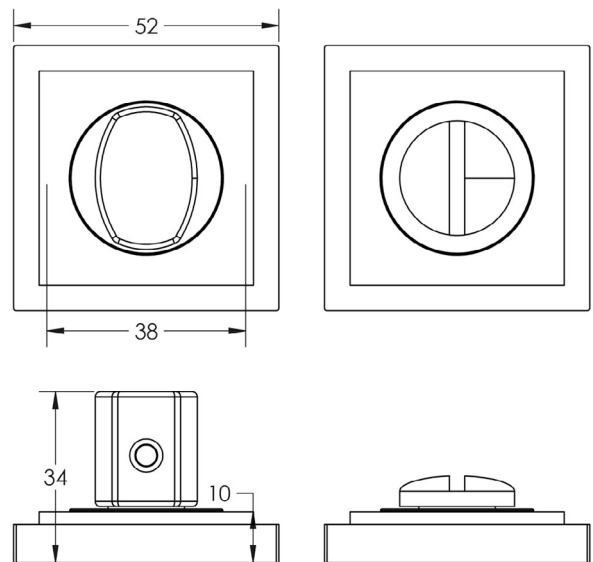

FINISHES

- Satin Brass

