

CODE

**BUR-40AB-456AB-82AB**

DESCRIPTION

**Lever On Plate With Turn & Release**

STANDARDS



PRODUCT SPECIFICATION

- 38mm centres
- Sprung
- Grade 4 corrosion
- Matt lacquered solid brass
- Back to back fixing recommended
- Suitable for doors 35-55mm
- *We strongly recommend requesting a sample before committing to any cutting or drilling*

TECHNICAL DRAWING

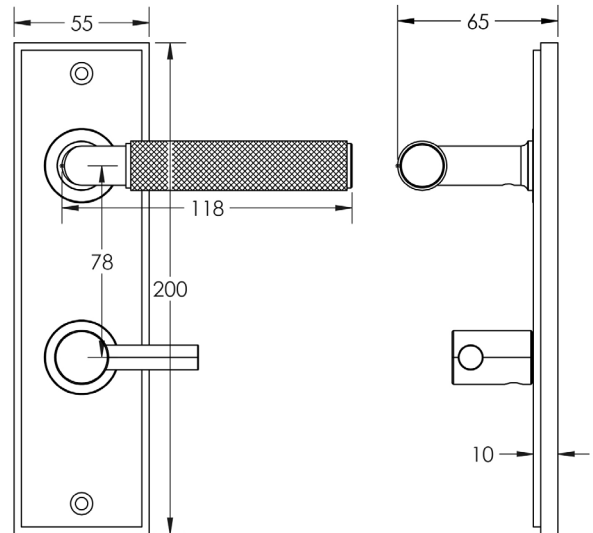

FINISHES

- Antique Brass

