

### CODE

**BUR-30AB-456AB-81AB**

### DESCRIPTION

**Lever On Plate With Turn & Release**

### STANDARDS



### PRODUCT SPECIFICATION

- 38mm centres
- Sprung
- Grade 4 corrosion
- Matt lacquered solid brass
- Back to back fixing recommended
- Suitable for doors 35-55mm
- *We strongly recommend requesting a sample before committing to any cutting or drilling*

### TECHNICAL DRAWING

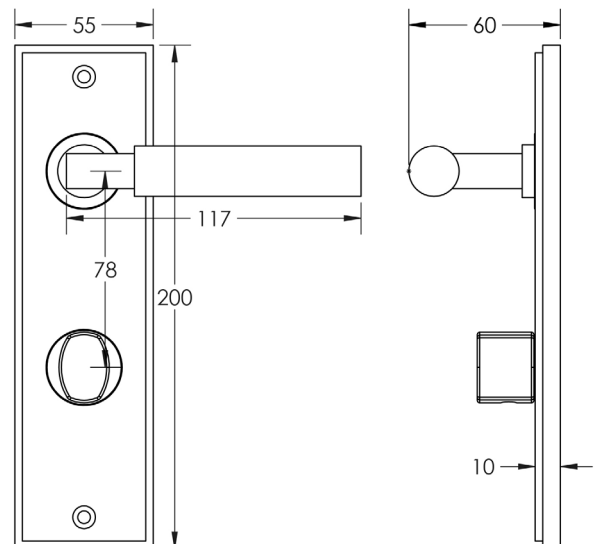

### FINISHES

- Antique Brass

